

CSTCR4M19G55B-R0

目前生产

RoHS

REACH

外观 & 形状

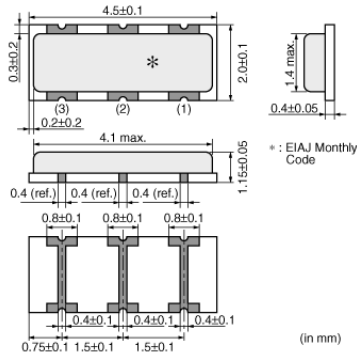

特点

MURATA's frequency adjustment and package technology expertise has enabled the development of the chip CERALOCK(R) with built-in load capacitors. This diverse series owes its development to MURATA's original mass production techniques and high reliability, and has achieved importance in the worldwide automotive market.

Features

1. The series has high reliability and is available for a wide temperature range.
2. Oscillation circuits do not require external load capacitors.
3. The series is available in a wide frequency range.
4. The resonators are extremely small and have a low profile.
5. No adjustment is necessary for oscillation circuits.

用途

汽车用途	动力传动/安全
其他用途	汽车级

包装信息

包装	规格	最小订购单位
-R0	180mm压纹带	3000

CSTCR4M19G55B-R0

规格

形状	SMD
频率	4.194MHz
频率公差	±0.5%
工作温度范围	-40°C to 125°C
频率温度特性	±0.15%
频率老化	±0.05%
清洗	available
谐振阻抗	60Ω
内置负载电容	39pF