

# CSTCE10M0G55A-R0

目前生产

RoHS

REACH

## 外观&形状

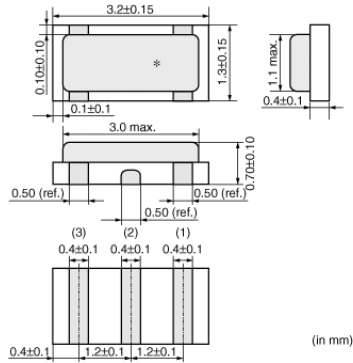

## 特点

MURATA's frequency adjustment and package technology expertise has enabled the development of the chip CERALOCK(R) with built-in load capacitors. This diverse series owes its development to MURATA's original mass production techniques and high reliability, and has achieved importance in the worldwide automotive market.

### Features

1. The series has high reliability and is available for a wide temperature range.
2. Oscillation circuits do not require external load capacitors.
3. The series is available in a wide frequency range.
4. The resonators are extremely small and have a low profile.
5. No adjustment is necessary for oscillation circuits.

## 用途

汽车用途	动力传动/安全
其他用途	汽车级

## 包装信息

包装	规格	最小订购单位
-R0	180mm压纹带	3000

# CSTCE10M0G55A-R0

## 规格

形状	SMD
频率	10.000MHz
频率公差	±0.5%
工作温度范围	-40°C to 125°C
频率温度特性	±0.2%
频率老化	±0.1%
清洗	available
谐振阻抗	40Ω
内置负载电容	33pF