

CSTLS6M00G53-A0

目前生产

RoHS

REACH

外观 & 形状

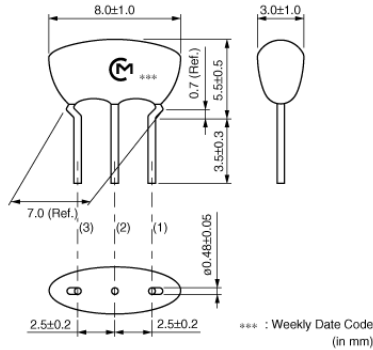

特点

MURATA's ceramic resonator, CERALOCK(R) with built-in load capacitors, has been widely applied as the most suitable component for clock oscillators in a broad range of microprocessors. The CSTLS series can be used in the design of oscillation circuits not requiring external load capacitors, enabling both high-density mounting and cost reduction.

Features

1. Oscillation circuits do not require external load capacitors. There is some variation in built-in capacitance values applicable to various IC.
2. Stable over a wide temperature range.
3. Compact, lightweight and exhibit superior shock resistance performance.
4. Enable the design of oscillator circuits requiring no adjustment.
5. Cost-effective and reliable availability.

用途

其他用途	消费级/工业级
------	---------

包装信息

包装	规格	最小订购单位
-A0	折叠盒装	2000

CSTLS6M00G53-A0

规格

形状	引线
频率	6.000MHz
频率公差	±0.5%
工作温度范围	-20°C to 80°C
频率温度特性	±0.2%
频率老化	±0.2%
清洗	Not available
谐振阻抗	30Ω
内置负载电容	15pF