

CSTCR5M00G55-R0

目前生产

RoHS

REACH

外观&形状

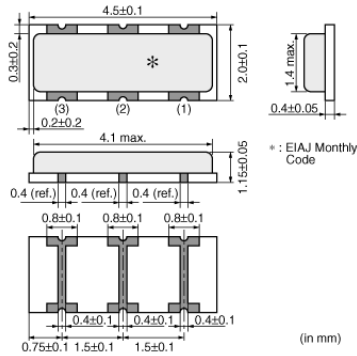

特点

MURATA's package technology expertise has enabled the development of the Chip "CERALOCK" with built-in load capacitors. High-density mounting can be realized because of the small package and the elimination of the need for an external load capacitor.

Features

1. Oscillation circuits do not require external load capacitors.
2. The series is available in a wide frequency range.
3. The resonators are extremely small and have a low profile.
4. No adjustment is necessary for oscillation circuits.

用途

其他用途	消费级/工业级
------	---------

包装信息

包装	规格	最小订购单位
-R0	180mm压纹带	3000

CSTCR5M00G55-R0

规格

形状	SMD
频率	5.000MHz
频率公差	±0.5%
工作温度范围	-20°C to 80°C
频率温度特性	±0.2%
频率老化	±0.1%
清洗	Not available
谐振阻抗	60Ω
内置负载电容	39pF